

WORLD ROBOT OLYMPIAD™



SWITZERLAND

Istruzioni di costruzione per la

World Robot Olympiad 2022
Categoria RoboMission, fascia d'età Junior

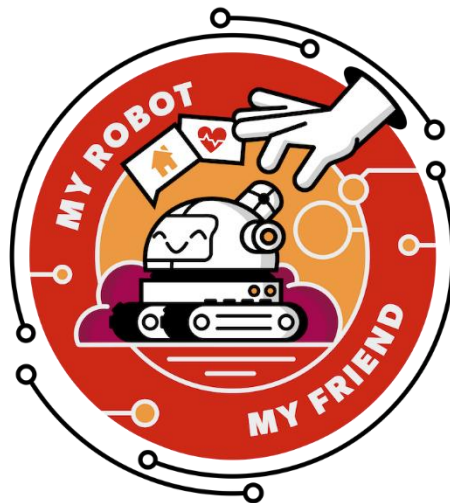

«The Rescue Robot»

Verein WRO CH – organizzatore ufficiale della World Robot Olympiad in Svizzera

Oggetto-sostanze chimiche (1x)

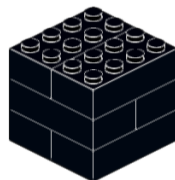
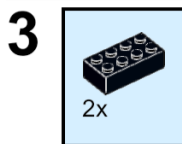
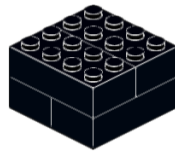
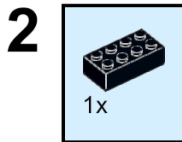
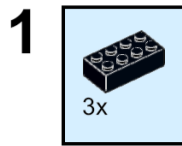

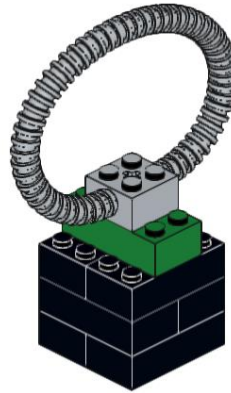
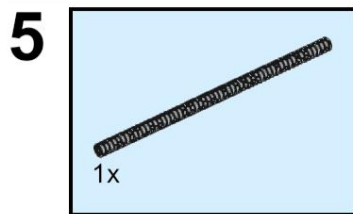
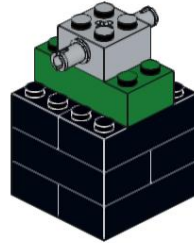
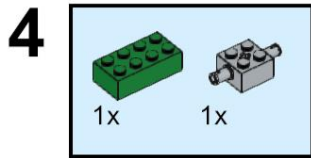

Oggetto-incendio (2x)

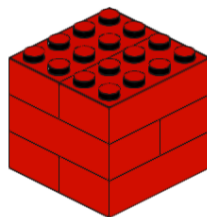
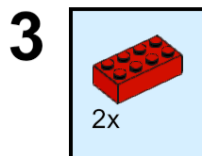
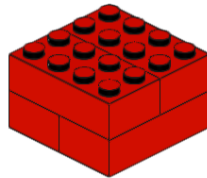
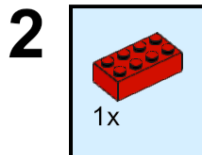
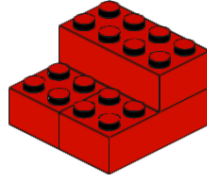
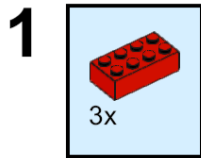

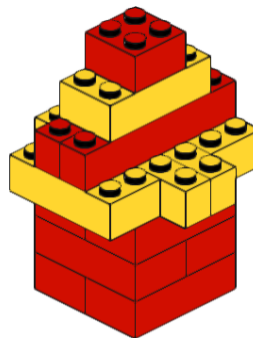
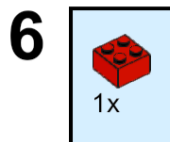
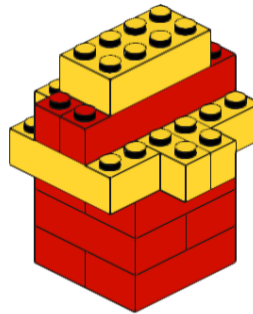
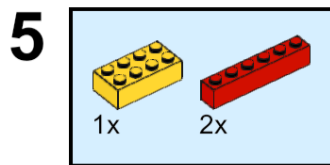
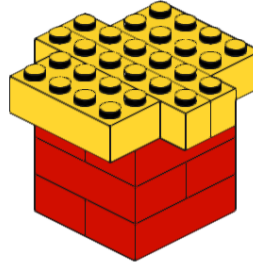
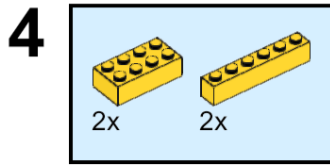

Blocchi di segnalazione (2x)

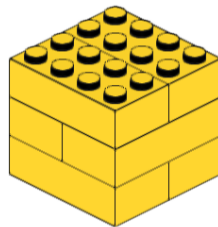
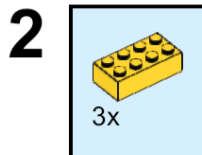
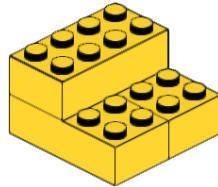
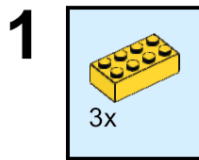

Persona di stanza grande (1x)

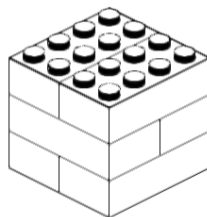
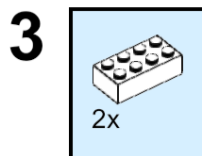
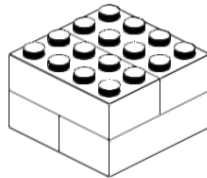
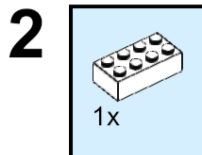
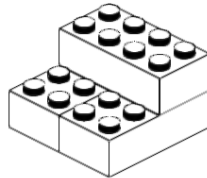
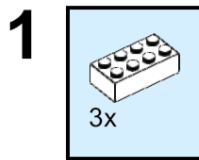

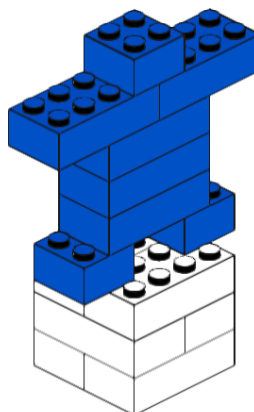
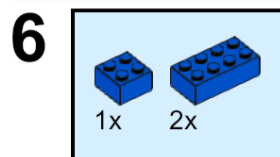
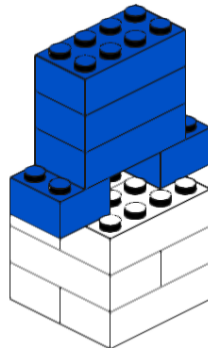
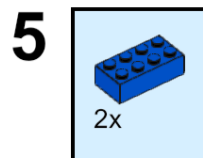
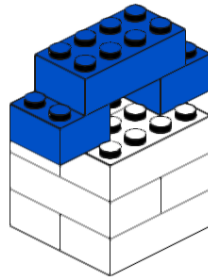
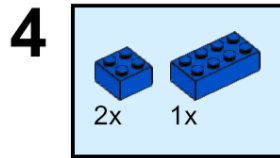

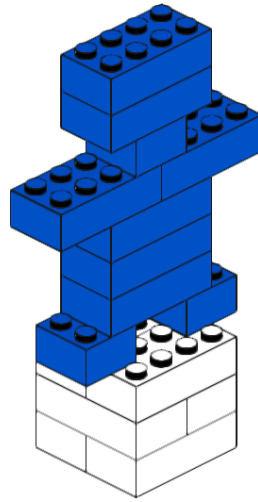
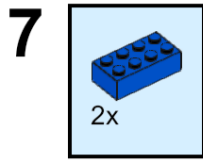

Persona di stazza piccola (1x)

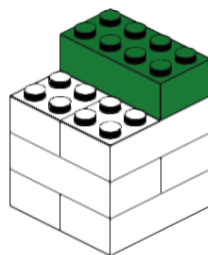
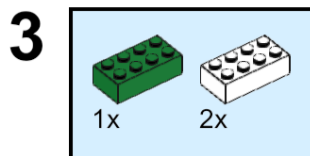
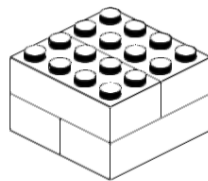
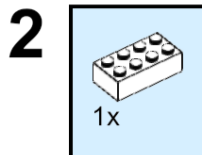
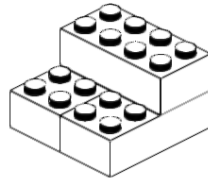
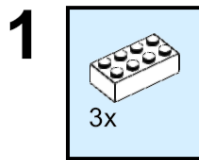

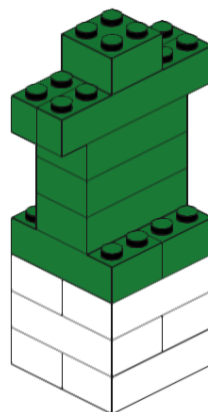
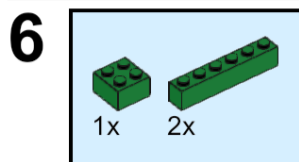
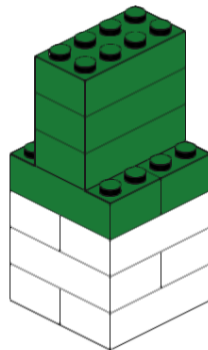
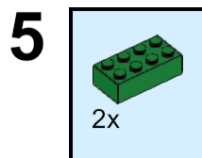
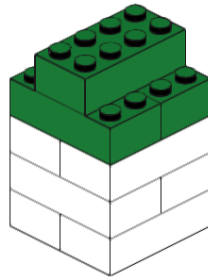
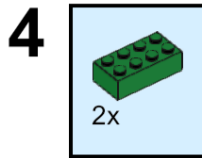

Parete di ostacolo (1x)

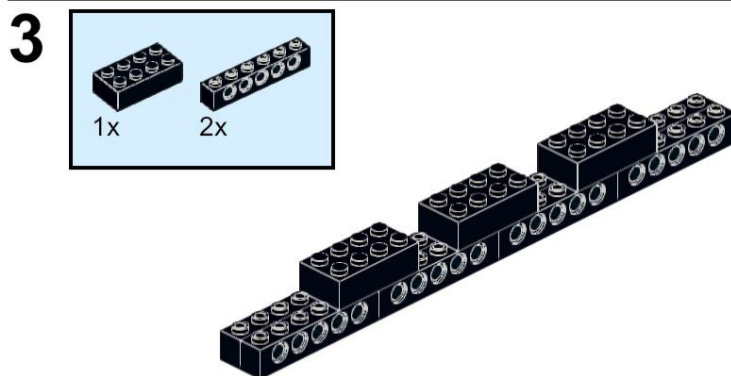
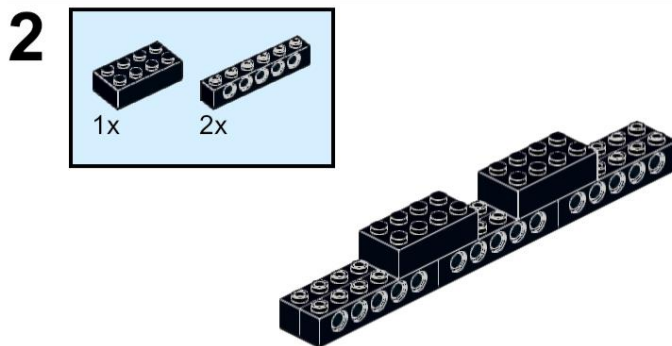
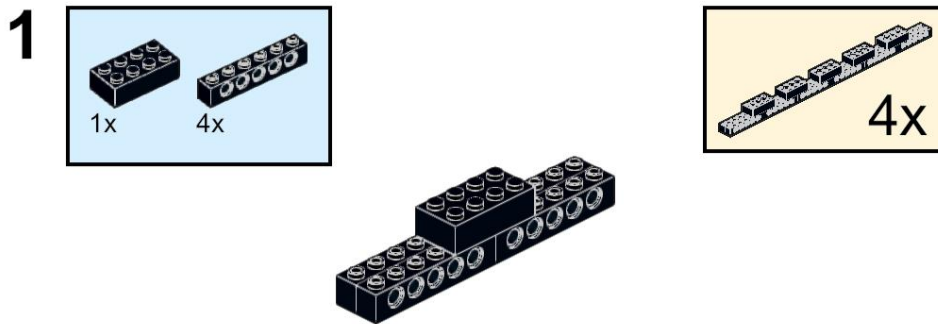

4

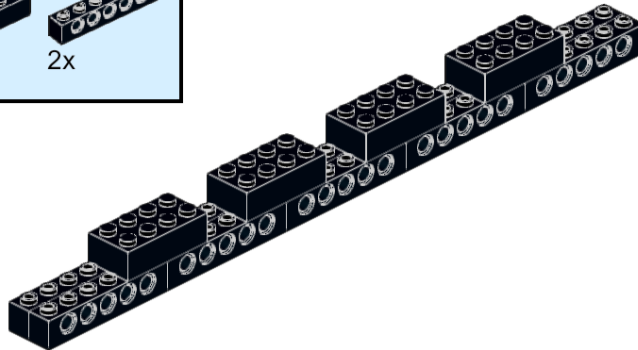
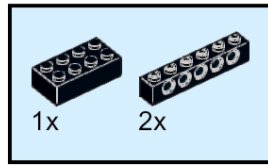

5

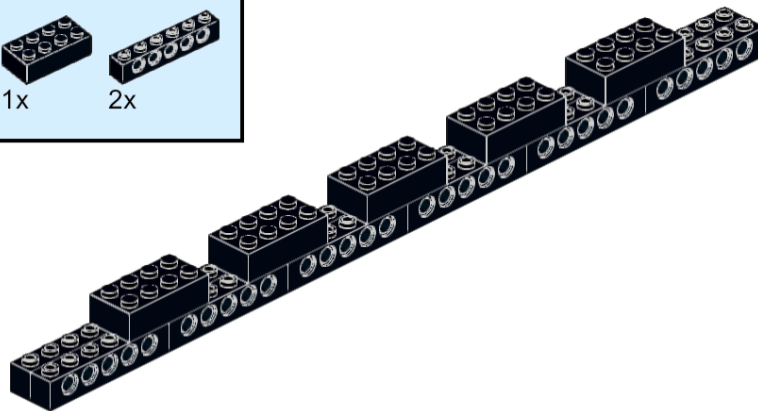
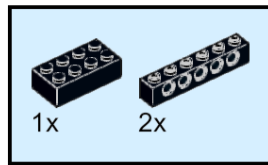

6

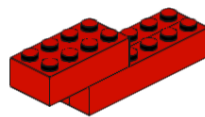
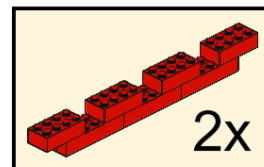
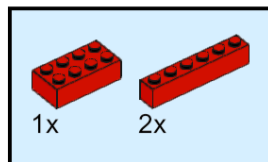

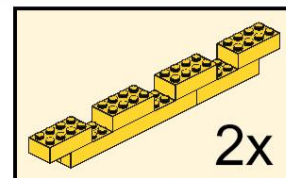
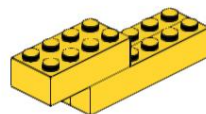
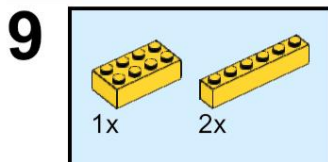
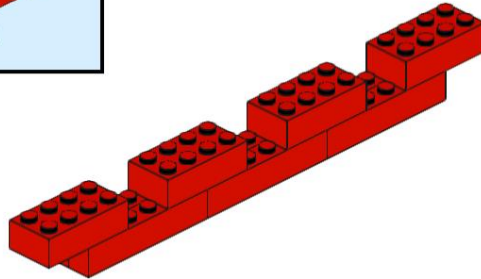
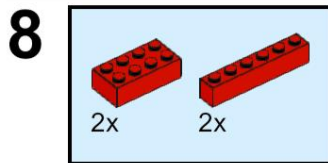
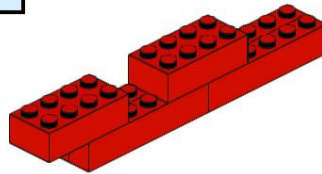
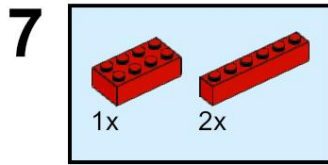

10

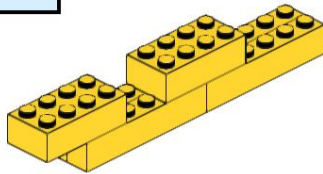
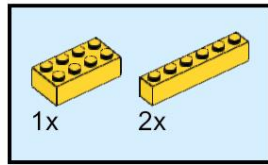

11

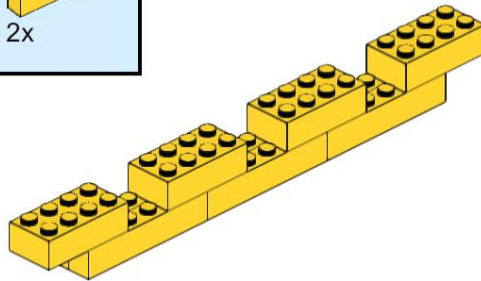
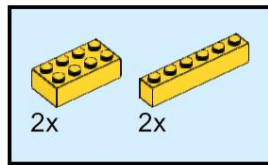

12

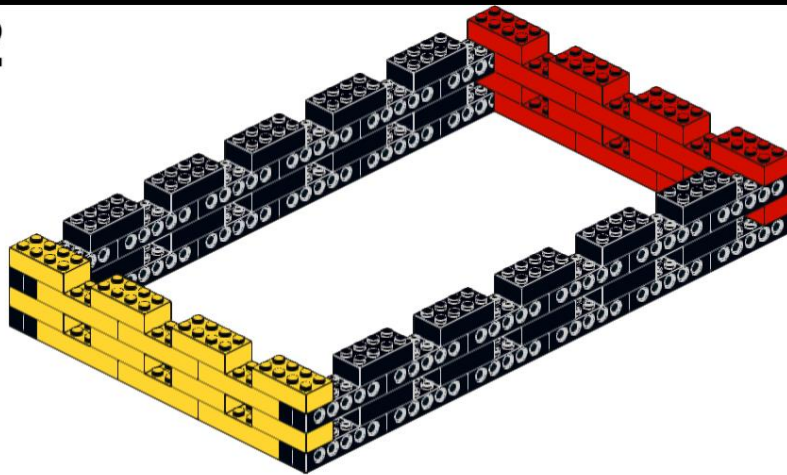

13

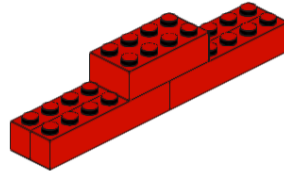
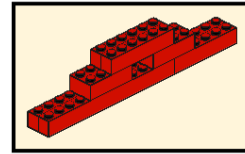
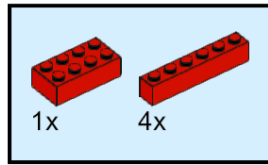

14

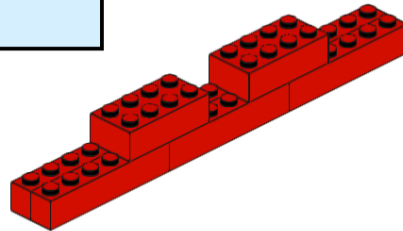
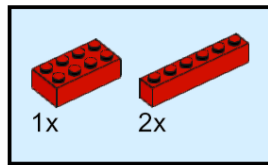

15

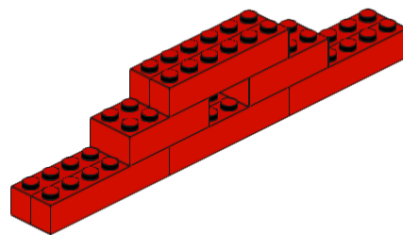
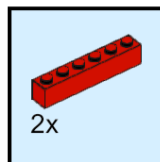

16

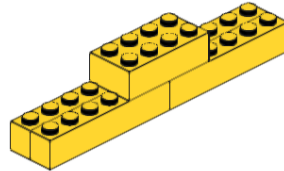
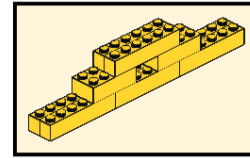
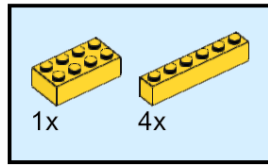

17

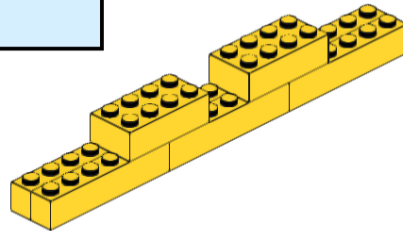
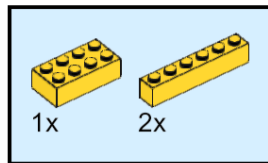

18

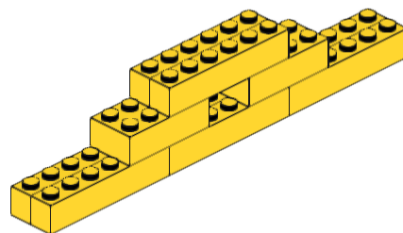
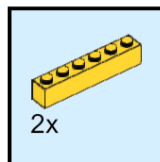

19

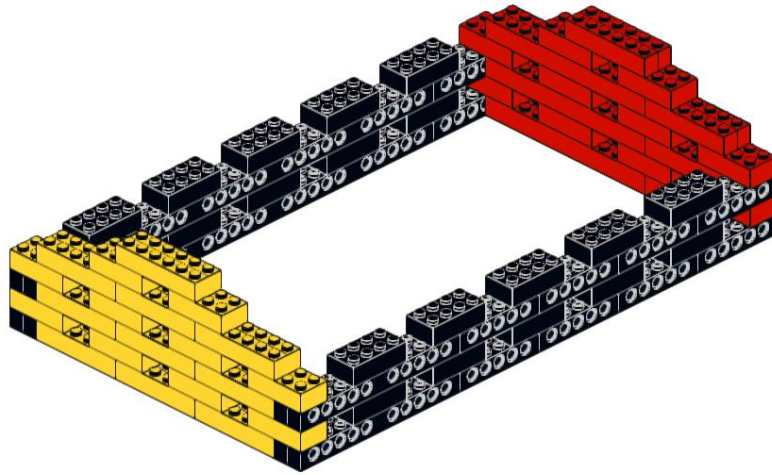

Parete trasversale (1x)

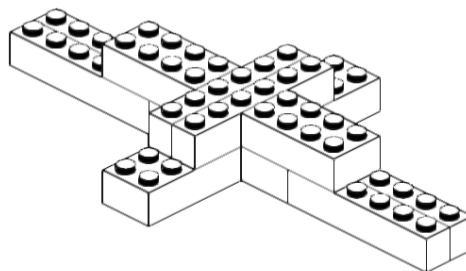
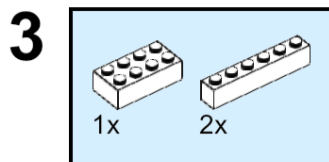
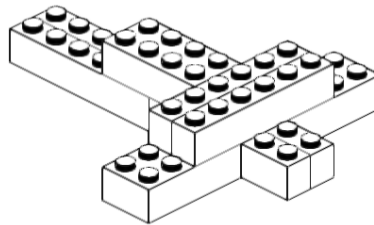
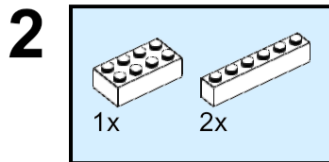
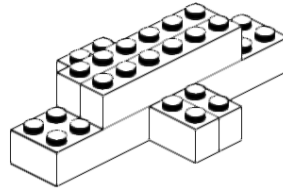
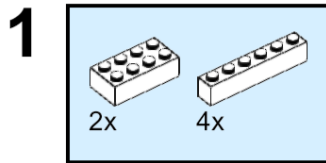

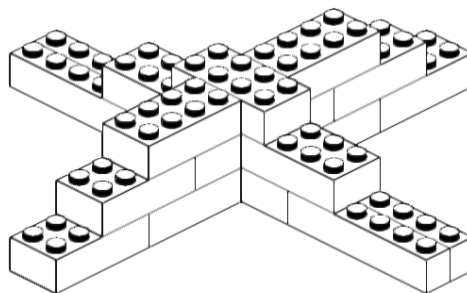
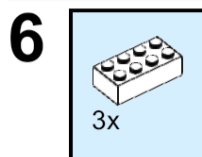
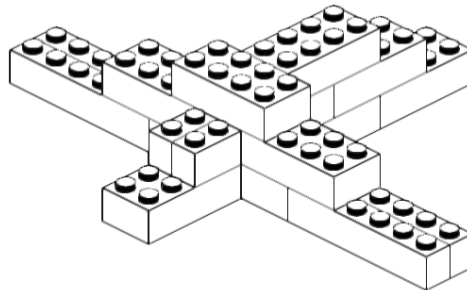
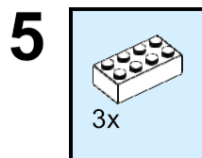
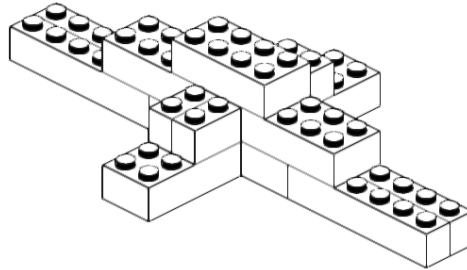
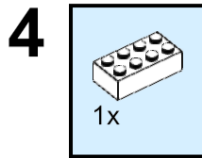

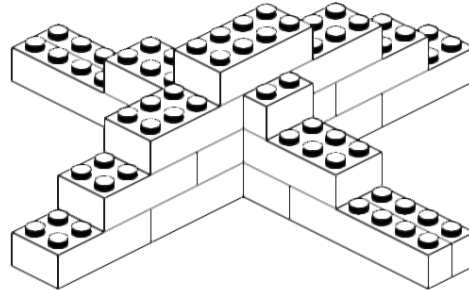
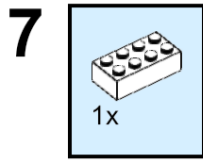

Parete diritta (1x)

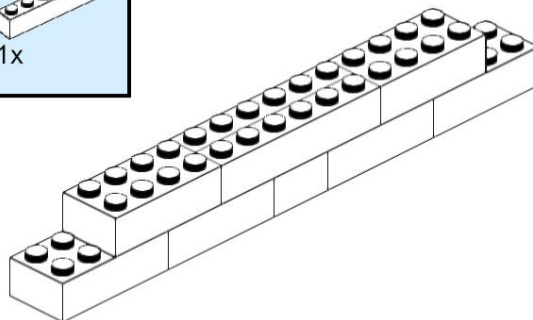
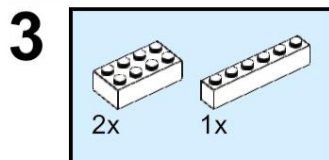
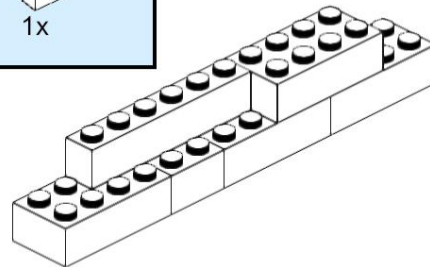
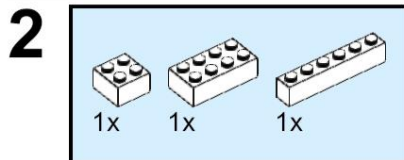
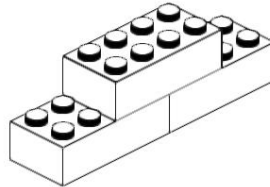
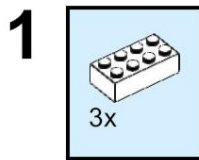

4

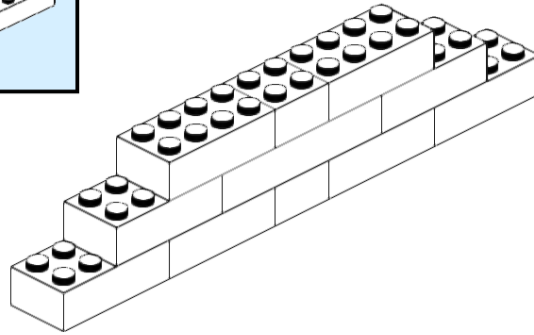
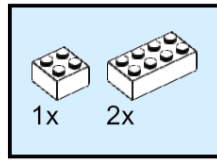

5

