

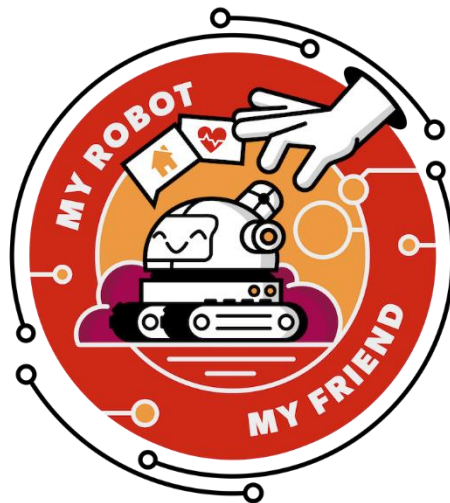

Istruzioni per la costruzione per la

**World Robot Olympiad 2022**  
**Categoria RoboMission, fascia d'età Elementary**



**«The Garden Robot»**

Verein WRO CH – organizzatore ufficiale della  
World Robot Olympiad in Svizzera

## Erba (3x)

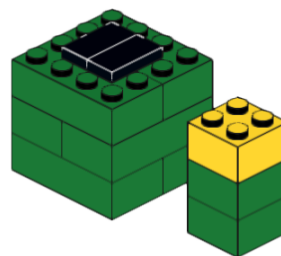
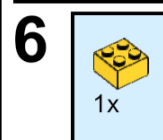
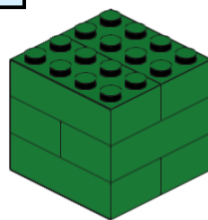
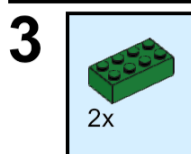
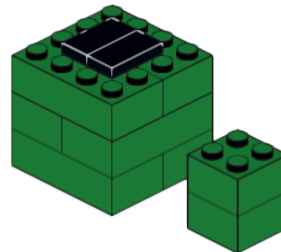
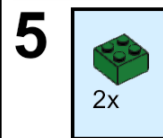
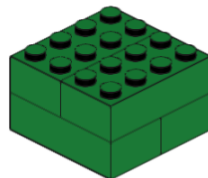
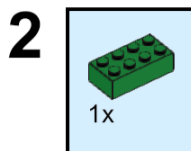
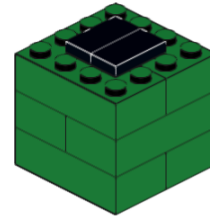
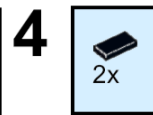
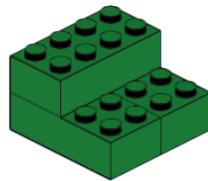
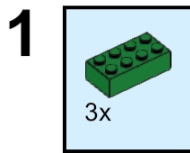

## Erba infestante (3x)

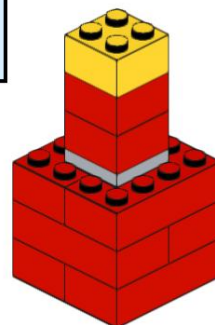
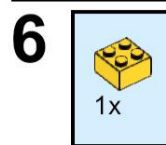
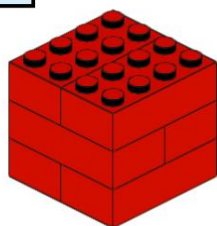
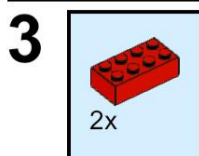
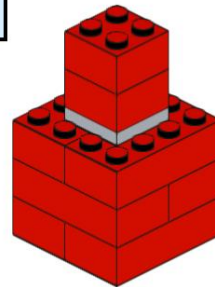
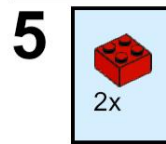
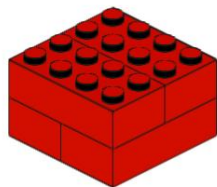
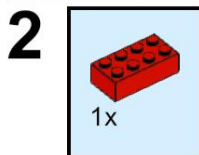
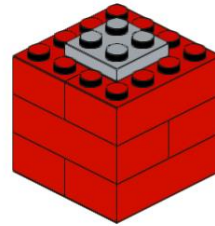
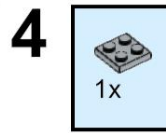
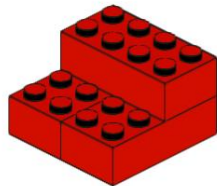
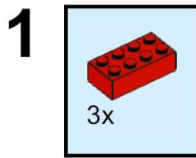

## Coccinelle (3x)

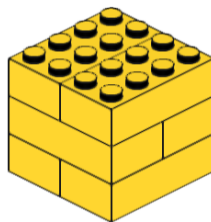
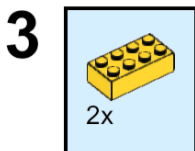
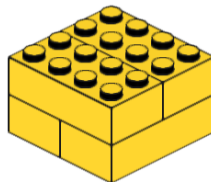
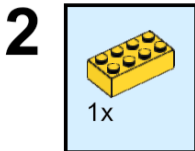
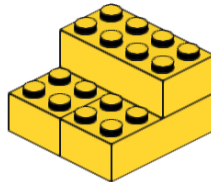
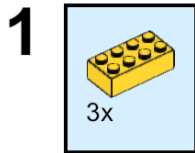

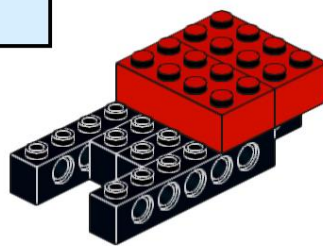
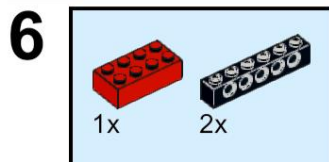
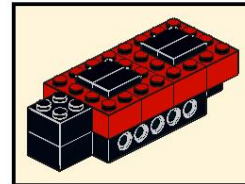
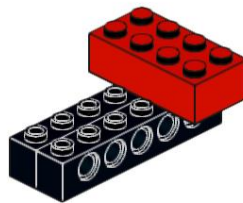
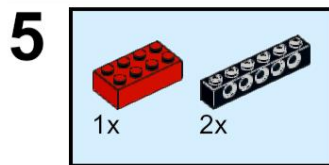
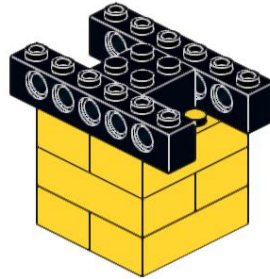
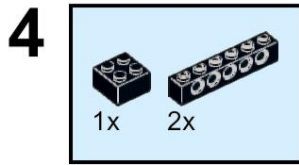

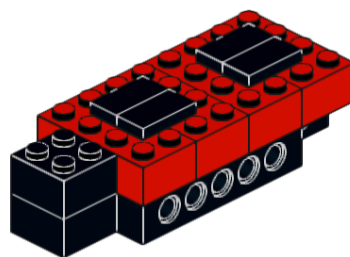
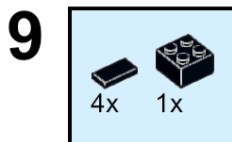
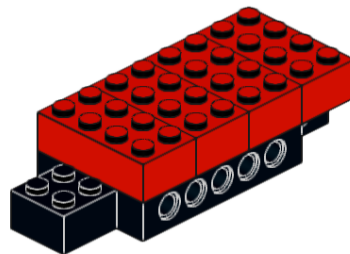
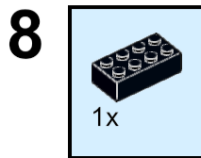
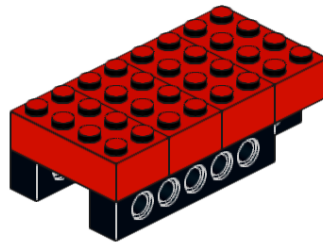
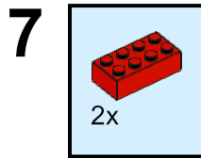

# 10

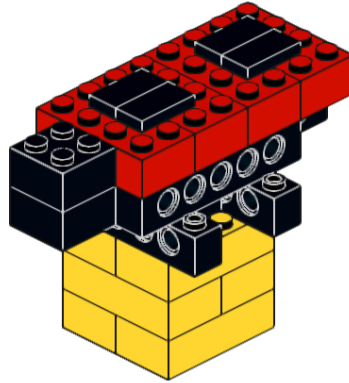

## Centro di servizio (1x)

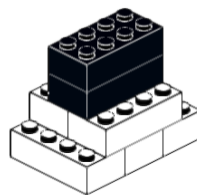
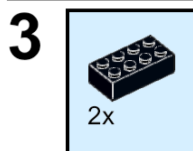
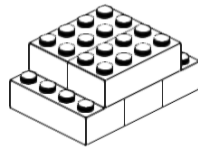
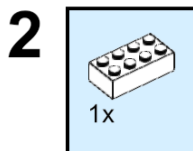
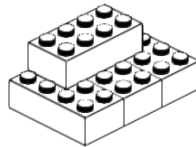
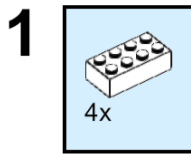



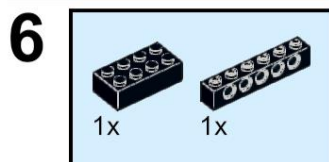
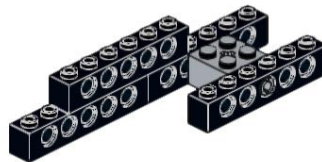
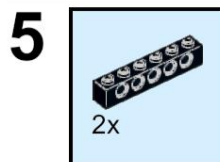
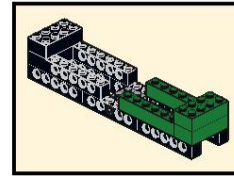
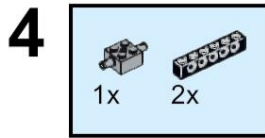

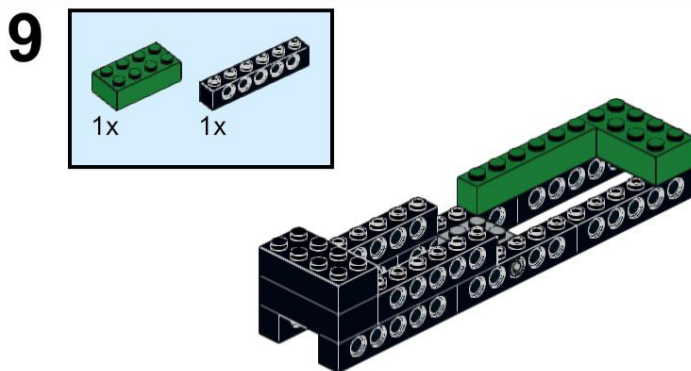
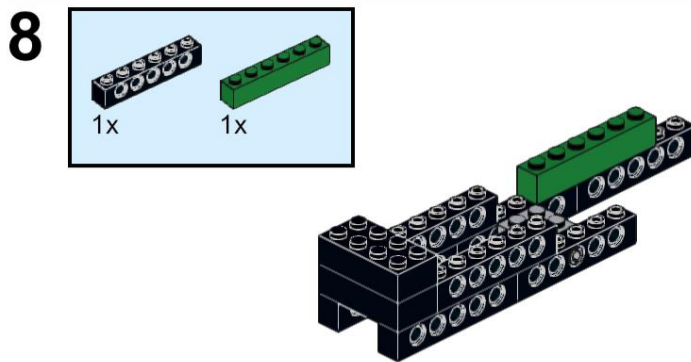
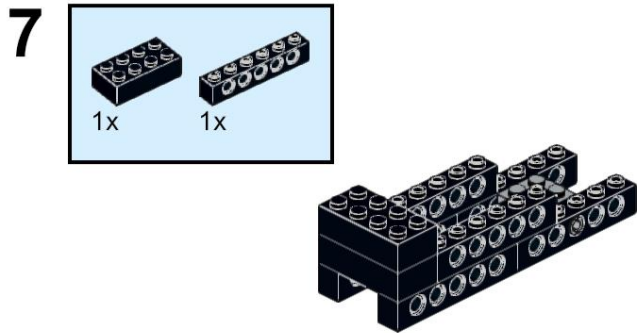

10

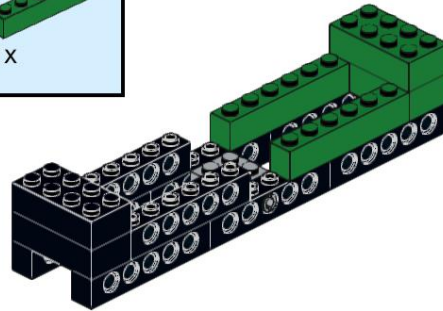
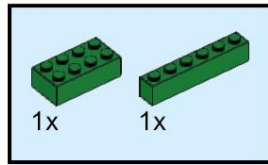

---

11

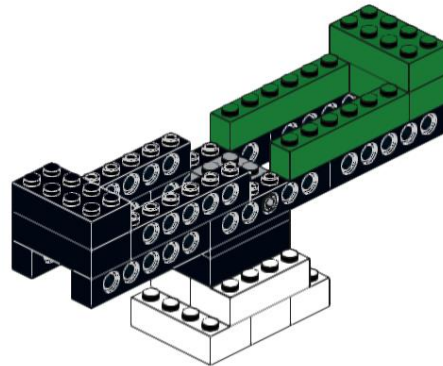

---

12



13

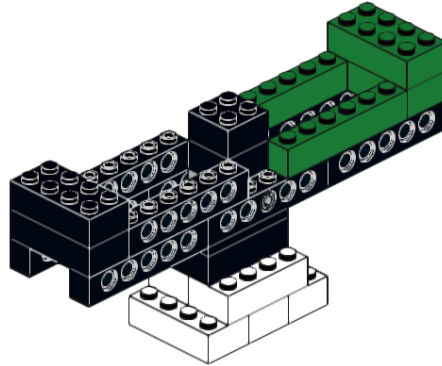
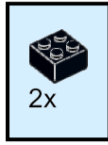

## Recinzioni (11x)

