

WORLD ROBOT OLYMPIAD™



SWITZERLAND

Bauanleitung für die

World Robot Olympiad 2022

Kategorie RoboMission, Altersklasse Elementary

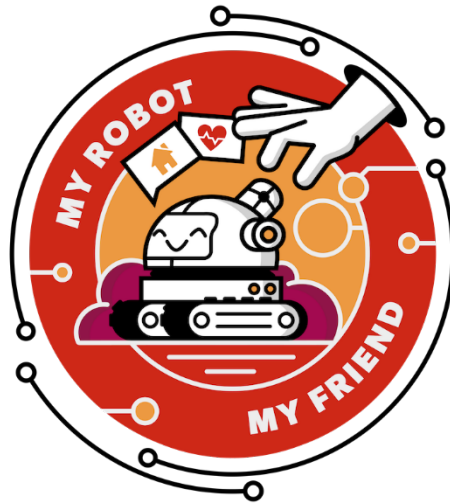

«The Garden Robot»

Verein WRO CH – Offizieller Organisator der
World Robot Olympiad in der Schweiz

Gras (3x)

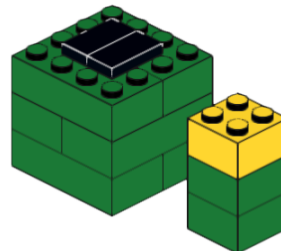
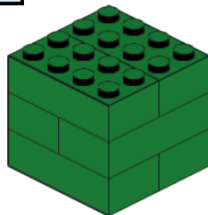
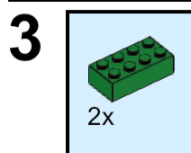
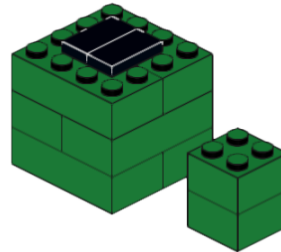
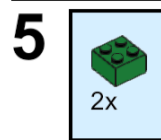
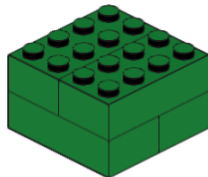
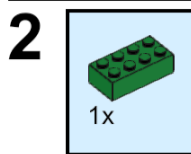
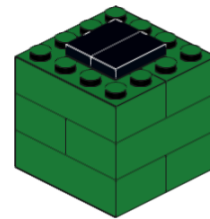
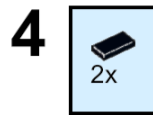
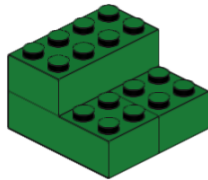
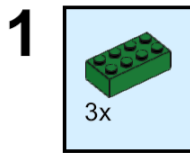

Unkraut (3x)

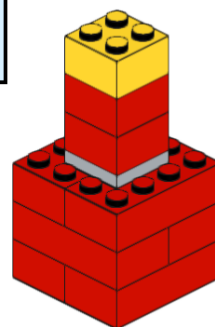
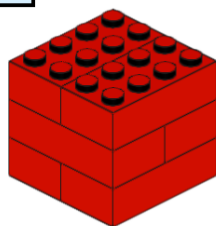
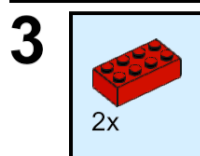
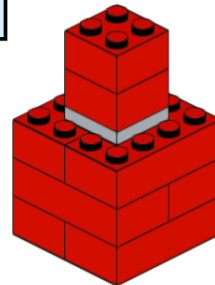
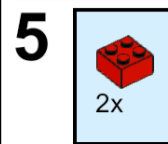
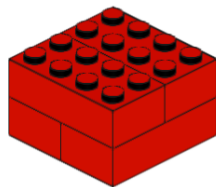
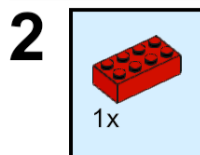
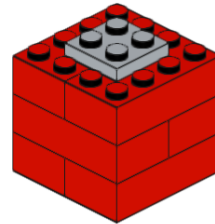
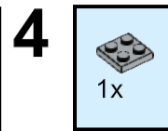
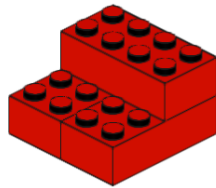
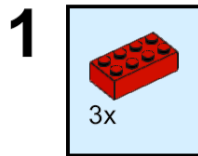

Marienkäfer (3x)

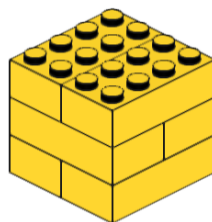
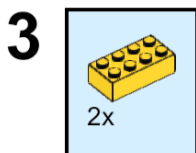
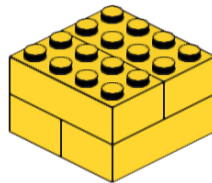
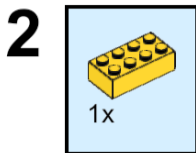
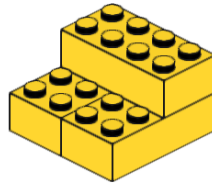
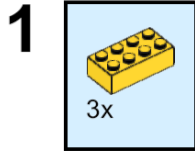

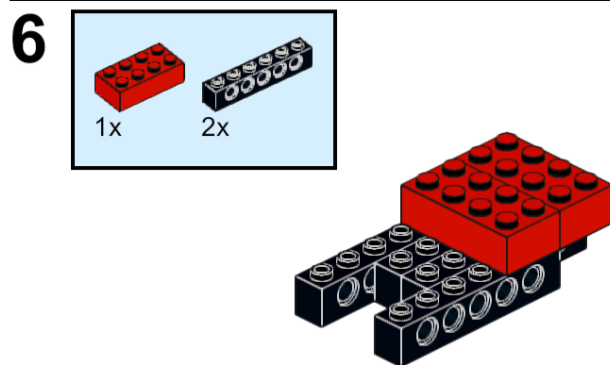
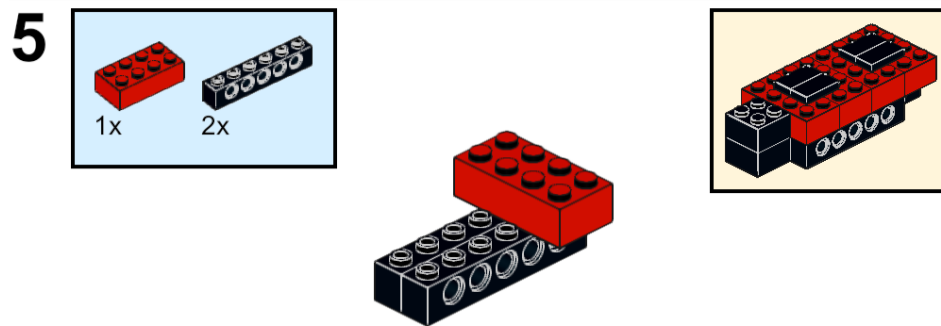
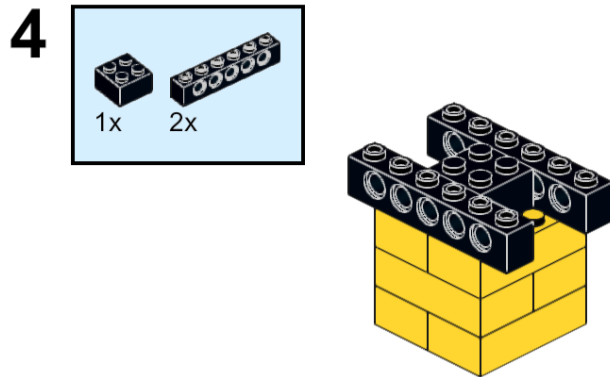

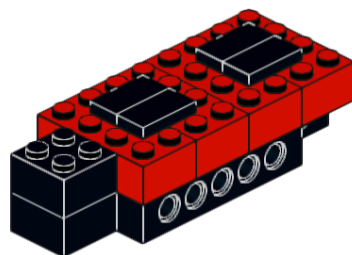
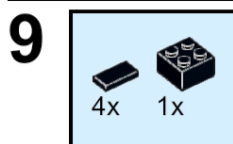
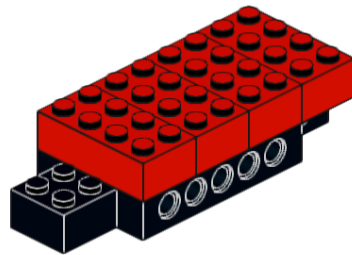
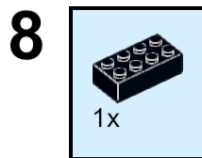
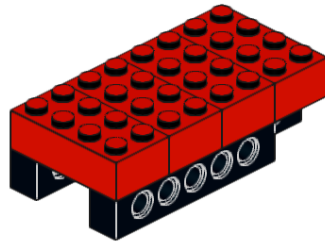
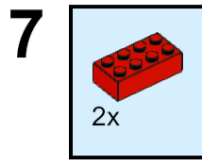

10

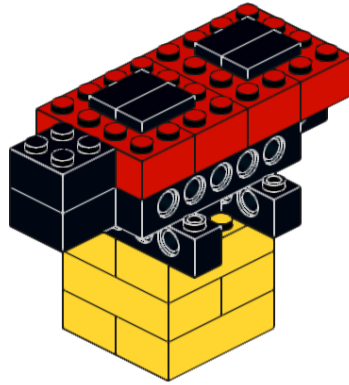

Servicestelle (1x)

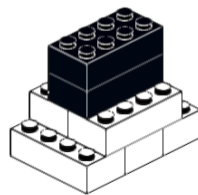
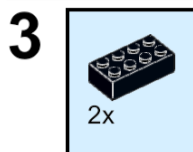
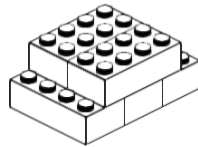
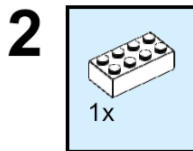
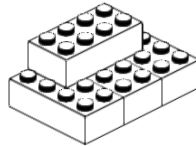
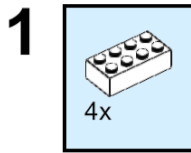

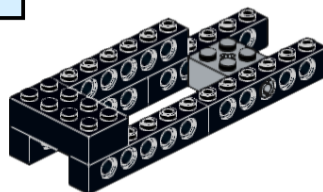
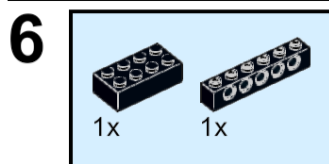
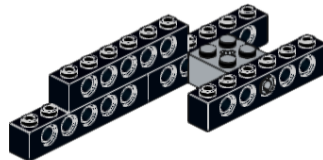
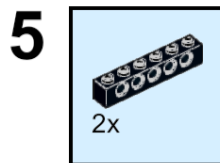
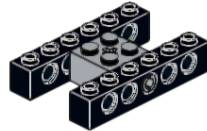
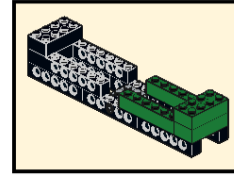
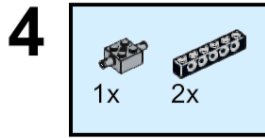

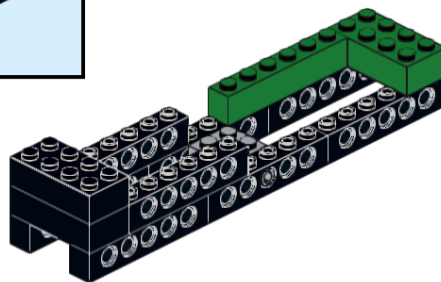
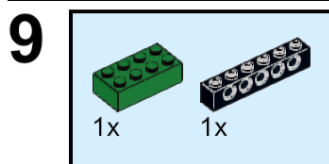
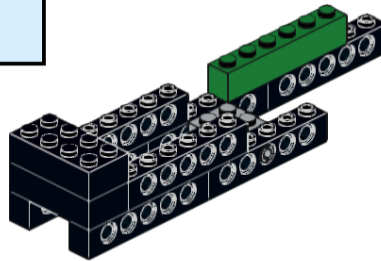
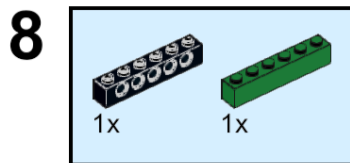
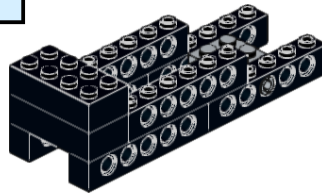
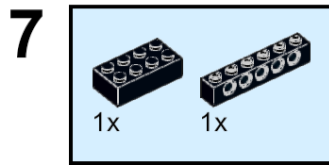

10

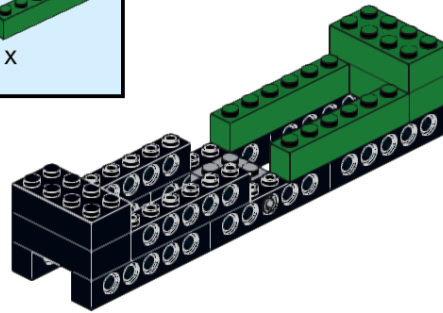
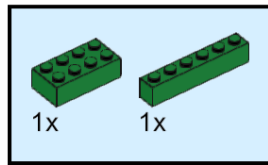

11

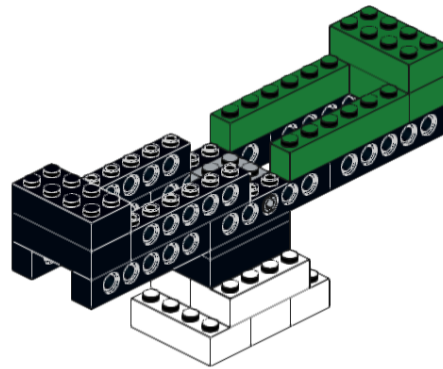

12

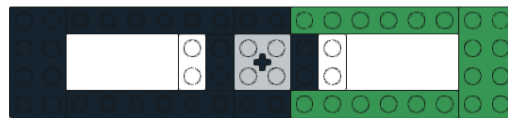

13

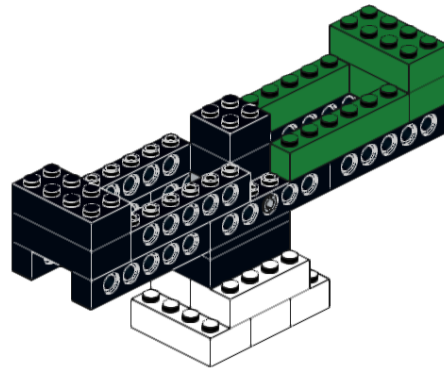
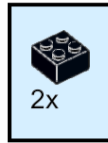

Zaun (11x)

